

Technical information **Dimensions** **Imperial** **Metric**

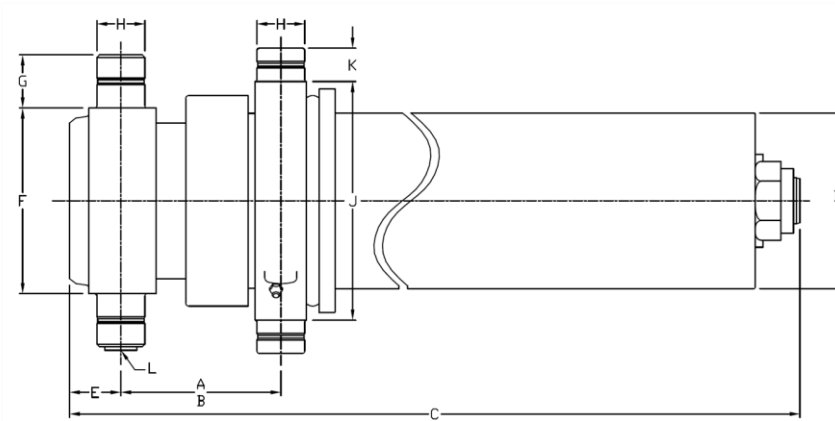

Dimensions	Imperial	Metric
A (stroke)	139.31 in	3 539 mm
B (closed)	6.25 in	159 mm
C	60.25 in	1 530 mm
D	6.63 in	168 mm
E	2.00 in	51 mm
F	7.00 in	178 mm
G	2.00 in	51 mm
H	1.88 in	48 mm
J	9.00 in	229 mm
K	1.25 in	32 mm
L	SAE-12	

Stage	Effective diameter		Effective area		Stroke	
1	5.000 in	127 mm	19.64 in ²	12 668 mm ²	46.63 in	1 184 mm
2	4.250 in	108 mm	14.19 in ²	9 152 mm ²	46.81 in	1 189 mm
3	3.500 in	89 mm	9.62 in ²	6 207 mm ²	45.88 in	1 165 mm

Specifications	Imperial	Metric
Weight without hydraulic fluid	354 lb	161 kg
Hydraulic fluid volume	9.9 gal. (US)	37 l
Maximum working pressure	2 750 psi	190 bar
Maximum pump flow	40 gpm	151 lpm
Maximum cylinder capacity*	29.6 US tons	26 853 kg

Installation components	Model	Part no.
Block	B-1875	PB3005002-A
Frame	AC-4030	PF3000013
Hinge	P-200 PEL-T	PP3004010

Cylinder capacity

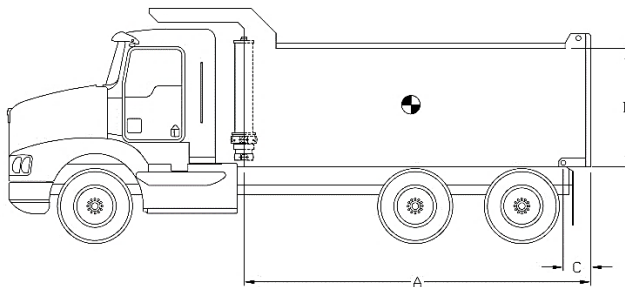

A = Body Length
 B = Body height
 C = Overhang

Note:	Body length	14.0 ft		15.0 ft		16.0 ft	
Cylinder capacities based on 90% of the maximum working pressure.	Overhang	0 in	6 in	6 in	12 in	12 in	18 in
	Dump angle	49.2°	51.2°	47.4°	49.2°	45.7°	47.4°
	Body height	Cylinder capacities in US tons at 2000 psi (at 2750 psi)					
For reference only. See www.mailhotindustries.com	36 in	22.7 (31.2)	24.3 (33.4)	23.1 (31.8)	24.7 (34.0)	23.6 (32.4)	25.2 (34.6)
	48 in	23.9 (32.9)	25.8 (35.5)	24.3 (33.4)	26.2 (36.0)	24.7 (34.0)	26.6 (36.6)
	60 in	25.3 (34.8)	27.6 (38.0)	25.7 (35.3)	27.9 (38.4)	26.0 (35.8)	28.2 (38.8)

* See product manual

Subject to change without notice, all rights reserved.

Item	Part no.	Description
------	----------	-------------

1	ROV059009-A	BASE TUBE Ø5.9
2	RMG050150-A	SECTION Ø5
3	RMG042149-A	SECTION Ø4.25
4	RNV035024-A	LAST SECTION Ø3-1/2
7	RK066114-A	COVER TUBE ASSEMBLED
8	RFG053006	END CAP Ø5-3/8
9	RFG053007	END CAP Ø5-3/8

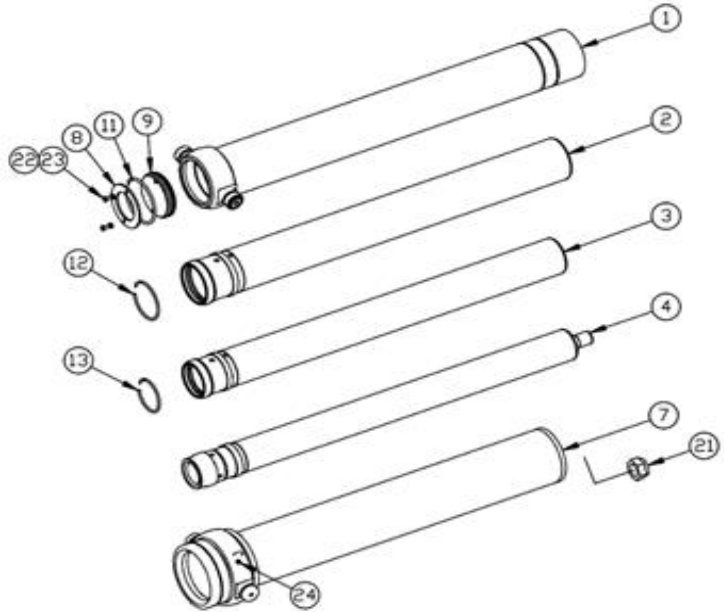

Snap ring kit Part no. : XB19G0503

Item	Description
------	-------------

11	SNAP RING Ø5-3/8
12	SNAP RING Ø4-1/2
13	SNAP RING Ø3-3/4

Hardware kit Part no. : ZX02G0503

Item	Description
------	-------------

21	STOVER NUT Ø1-3/4-12 NF GRADE C
22	SERRATED SPRING LOCK WASHER
23	HEX. BOLT Ø3/8-16 UNC X 3/4 LG GRADE 5
24	GREASE FITTING STRAIGHT 1/8 NPT

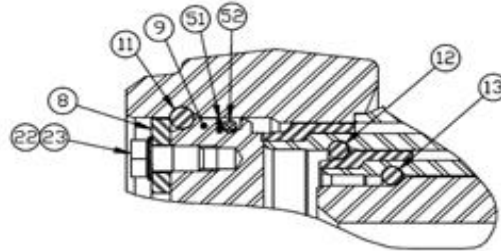

Seal kit Part no. : UI47G0503

Item	Description
------	-------------

31	U-CUP Ø5-3/8 X Ø5 X 3/8
32	U-CUP Ø4-5/8 X Ø4-1/4 X 3/8
33	U-CUP Ø3-7/8 X Ø3-1/2 X 3/8
41	WIPER Ø5
42	WIPER Ø4-1/4
43	WIPER Ø3-1/2
51	BACKUP RING Ø5-3/8 X Ø5
52	O-RING Ø5-3/8 X Ø5

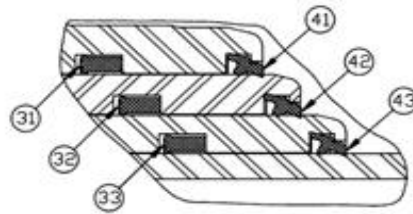

* See product manual

Subject to change without notice, all rights reserved.