

USER GUIDE

G Series telescopic cylinder





TABLE OF CONTENTS

TABLE OF CONTENTS	2
USER RESPONSIBILITY	3
GENERAL INFORMATION	3
MANUFACTURER REMINDER	3
DISCLAIMER	3
DECALS INFORMATION	4
G-SERIES CYLINDER PARTS DESCRIPTION	6
1. CYLINDER SELECTION	7
1.1. APPLICATION	7
1.2. ENVIRONMENT	7
2. CYLINDER INSTALLATION	8
3. GOOD USE AND OPERATION OF THE CYLINDER	9
4. RECOMMENDATIONS TO PROPERLY MAINTAIN YOUR CYLINDER	10
4.1. DAILY INSPECTION ROUTINE IS ESSENTIAL	10
4.2. WEEKLY MAINTENANCE AND LUBRICATION	10
4.3. SERVICING A CYLINDER - PRESSURISED OIL	11
4.4. CYLINDER AND HYDRAULIC SYSTEM REQUIREMENT	11
4.5. HYDRAULIC OIL	11
4.6. HANDLING	11
4.7. RECOMMANDATIONS FOR SEAL MAINTENANCE AND PARTS REPLACEMENT	12
4.8. SUGGESTIONS FOR CYLINDER REPLACEMENT	12
4.9. STORAGE OF CYLINDER	13

USER RESPONSIBILITY



WARNING

Inadequate cylinder selection, installation and testing, operation or maintenance of your cylinder which is a part of the lifting mechanism may cause cylinder's malfunction or failure which may result in death, injuries and/or property damage.

The installer having technical expertise and users are responsible to adequately select, install, validate and test, operate and maintain in accordance with safety and warning requirement,

all aspect of the application, cylinder specification, industries standard and additional information provided from "Mailhot Industries Inc." and any other manufacturers of the lifting equipment.

GENERAL INFORMATION

This manual has been conceived to give you all necessary informations on the G-SERIES telescopic cylinder manufactured by "Mailhot Industries Inc." You will find recommendations to follow for cylinder selection, installation, operation and maintenance.

We believe that this manual is important to enhance the quality of service rendered by "Mailhot Industries Inc." Customer service and satisfaction is a key element of the success of our company

MANUFACTURER REMINDER

Before starting to service your G-SERIES telescopic cylinder, please verify if the warranty is still valid on your product. Servicing the cylinder without the consent of "Mailhot Industries Inc." and/or with a valid warranty could void it. Please contact the Mailhot customer service to obtain an "R.G.A."

TEL: (800) MAILHOT

St-Jacques, Quebec, Canada
Guelph, Ontario, Canada
Edmonton, Alberta, Canada
Hudson, New Hampshire, USA
Silao, Gto, Mexico

service@mailhotindustries.com
ontario@mailhotindustries.com
alta@mailhotindustries.com
mailhotnh@mailhotindustries.com
mexico@mailhotindustries.com

DISCLAIMER

This brochure is intended to be used as a guide to normally selecting, installing, operating and your G-SERIES telescopic cylinder from "Mailhot Industries Inc." All suggestions and guidelines should only be used as reference only. "Mailhot Industries Inc." will not be liable and is not responsible for damages due to lack of compliance of following suggestions and guidelines. Please contact your local "Mailhot Industries Inc." dealer for any interpretation of the content of this manual.



WARNING

Read and understand this user guide before using the equipment. Failure to follow these instructions may cause the cylinder's malfunction which may result in death, injuries and/or property damage

DECALS INFORMATION

The following warning decals must be present on cylinder and visible by the equipment operator. In the case of painted decals, peel-off must be removed or new decal must be use. In the case of hidden cylinder, decals must be placed to the side of dump body, or cab, near driver or according to dump body manufacturer instructions.

Decal #YB003-0916: Daily inspection required

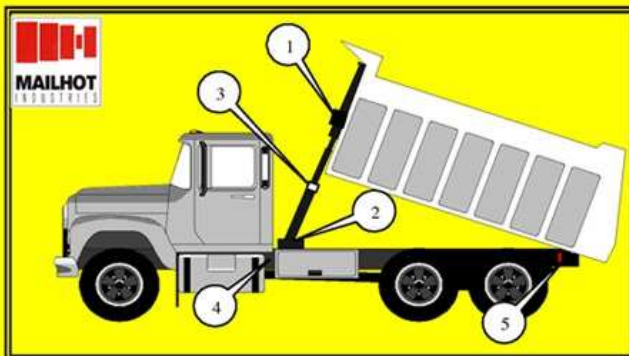

DAILY INSPECTION REQUIRED



WARNING

Failure to follow the recommended operating procedure may result in serious property damage or/and personal injuries or death.

- Ensure that all mounting blocks, bolts and cover oscillating collar (1 and 2) that hold the cylinder to the body are lubricated, secure, and not worn.
- Ensure that the gland nuts at the top of each tube for M and C models (3) are tight and secured.
- Ensure that all hoses and fittings (4) are in good condition and are secured out of harms way.
- Ensure that rear hinges (5) are lubricated, secure and without excessive wear.
- Ensure that cover (1) attached to cylinder (3) is secure and without damage.
- Refer to cylinder and equipment user manual.

For additional information:
www.mailhotindustries.com

INSPECTION QUOTIDIENNE NÉCESSAIRE



AVERTISSEMENT







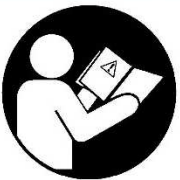

Ne pas suivre cette procédure de vérification pourrait occasionner des bris sérieux et/ou des blessures corporelles sérieuses ou mortelles.

- S'assurer que les blocs d'ancrage, vis, écrous et le capot à la sphère oscillante (1 et 2) qui retiennent le vérin au camion sont lubrifiés, solidement fixés et ne sont pas endommagés.
- S'assurer que les glandes situées en haut de chacun des tubes des vérins modèles M et C (3) sont bien vissées bien en place.
- S'assurer que tous les tubes et adaptateurs hydrauliques (4) sont en bonne condition et placés de façon sécuritaire.
- S'assurer que les pentures arrières (5) sont lubrifiées et ne sont pas endommagées ou usées excessivement.
- S'assurer que le capot (1) ne soit pas endommagé et soit solidement fixé au vérin (3).
- Se référer au manuel de l'utilisateur du vérin et du camion.

Pour plus d'information :
www.mailhotindustries.com

YB003-0916

Decal #YB0037-0614: General warning for dumping application

	 <h1 style="margin: 0;">WARNING</h1> YB0037-0614	
<p>EN Read and understand operators manual before using this equipment.</p> <p>FR Lire et comprendre les manuels de l'opérateur avant d'utiliser cet équipement.</p> <p>ES Lea y entienda el manual del operador antes de usar este equipo.</p>		
<p>EN Failure to follow these instructions may cause the cylinder's malfunction which may result in death, injuries and/or property damage.</p> <p>FR Le non respect de ces consignes peut entraîner la défaillance du cylindre pouvant engendrer des dégâts matériels, des blessures et/ou la mort.</p> <p>ES El incumplimiento de estas instrucciones puede causar la falla del cilindro, causar daños materiales, lesiones y/o muerte.</p>		
 <h1 style="margin: 0;">WARNING</h1>		
		<p>EN Always dump on firm and even ground.</p> <p>FR Toujours décharger sur terrain plat et ferme.</p> <p>ES Descargue siempre sobre suelo firme y nivelado.</p>
		<p>EN Never drive with a raised dump body.</p> <p>FR Ne jamais rouler avec une benne élevée.</p> <p>ES No conduzca nunca con el volquete levantado.</p>
		<p>EN Stay out of the working area of an operating dump body.</p> <p>FR Rester hors de la zone de travail lorsque la benne est en opération.</p> <p>ES Permanezca fuera del área de trabajo del camión volquete en operación.</p>
		<p>EN Do not overload and load evenly.</p> <p>FR Ne jamais surcharger et toujours répartir le chargement.</p> <p>ES Nunca sobrecargue el volquete y siempre distribuya la carga.</p>
		<p>EN Never be under an unsupported body.</p> <p>FR Ne jamais être sous une benne non supportée.</p> <p>ES Nunca estar debajo del volquete sin soporte.</p>
<p>EN This cylinder is not designed to be used as a structural member or to be subject to side loads or used under abnormal usage.</p>		
<p>FR Ce vérin n'est pas conçu pour être utilisé comme élément structurel ou pour travailler sous l'effet de charges latérales ou être utilisé sous des conditions anormales.</p>		
<p>ES Este cilindro no está diseñado para ser utilizado como un elemento estructural o para trabajar bajo el efecto de las cargas laterales o para usarse en condiciones anormales.</p>		

G-SERIES CYLINDER PARTS DESCRIPTION



**COVER
CYLINDER**

**PIN-TO-PIN
CYLINDER**

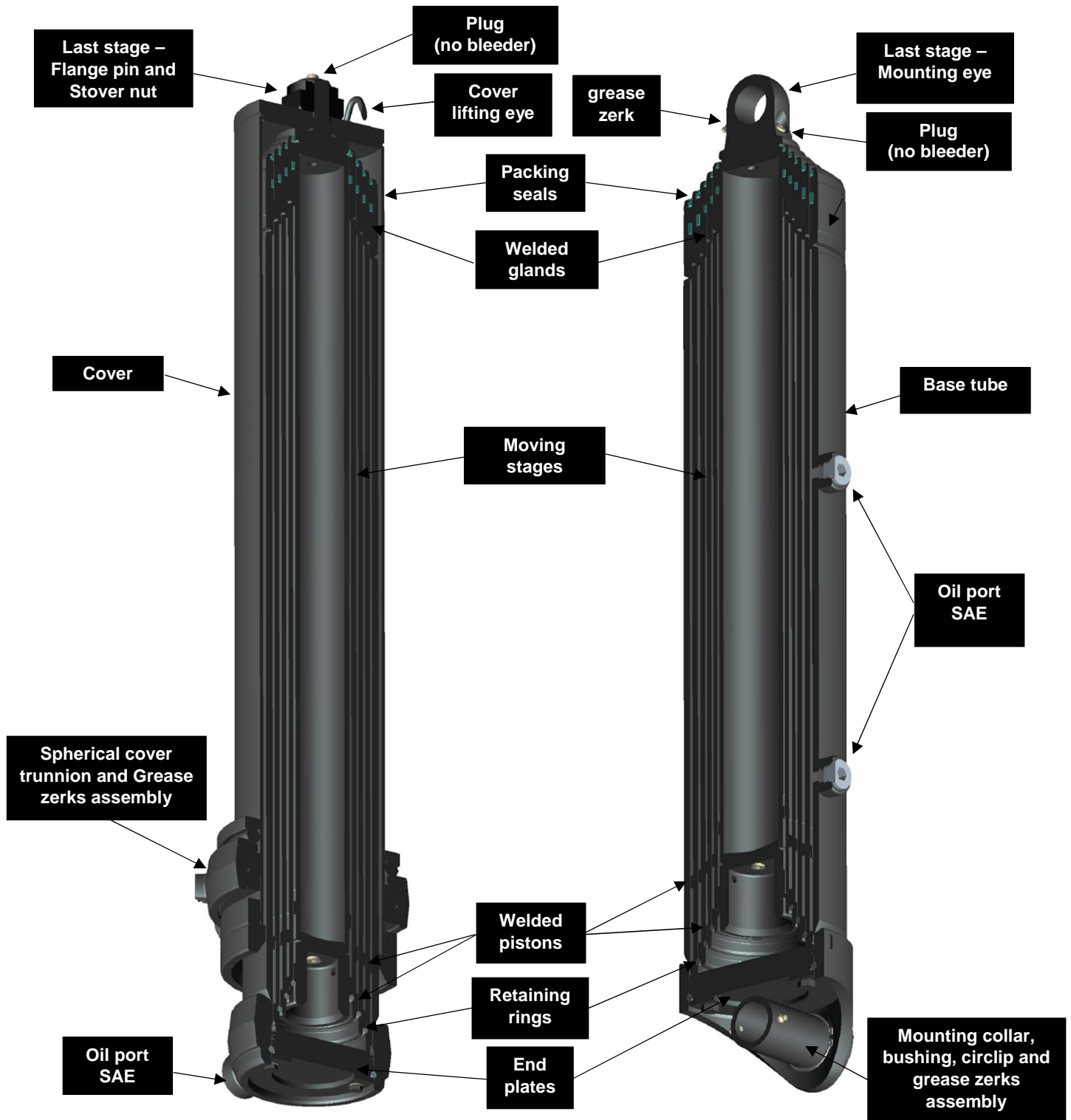

1. CYLINDER SELECTION



WARNING

Telescopic cylinders are not design to be used as a structural member or to be side loads or used under abnormal usage. The cylinder is strictly a lifting device is not a structural member of the unit and cannot be used to provide stability to the dumping unit.

CAUTION

- The hydraulic cylinder will not withstand lateral or side pressure when the unit is leaning.

Cylinder must be selected with adequate analysis of the application and environment in accordance with product specifications and restrictions. Following suggestions can be follow as guidelines for proper selection and installation.

1.1. APPLICATION

The G-SERIES telescopic cylinders are designed for dumping application such as dump truck and trailers. These type of vehicles are rollover or tilt sensitive due to external condition. Therefore, it is important to understand these working condition and design criteria prior to select and use such of cylinder.

1.2. ENVIRONMENT

All stages of the G-SERIES telescopic cylinders are 100% salt bath nitrided which is providing good resistance against corrosion, wear and scores when stages are exposed to typical environment and working condition. Unlike chrome, this treatment does not add material to the tube surfaces which can peel-off. Instead, it treats the surface making it harder and more corrosion resistant. Additional option is available when environment becomes too aggressive such has our G4 Series for salt spreader equipment.

With our best selection of seals, made of low temperature material, our G-SERIES telescopic has an intermittent recommended application temperature range of as -40 degrees F (-40°C) to +212 degrees F (100°C).

2. CYLINDER INSTALLATION



WARNING

Over pressurizing the cylinder can cause severe injury or death and/or damage to cylinder and equipment

CAUTION

- Cylinder installation should only be performed by trained and/or qualified personnel, otherwise, serious damage and/or injury is possible.
- Do not operate cylinder above factory maximum pressure which is typically 2,000 psi unless specified on cylinder or product datasheet. A relief valve should be used to prevent pressure peak exceeding specified maximum working pressure.
- An oil filter (10 micron) should be installed to keep the oil clean and contamination must not exceed the 20/18/15 class of ISO 4406 standard to prevent premature seal deterioration.
- The hydraulic cylinder mounted in the unit should be free to find its own trajectory line of extension, free of any lateral loading of the plungers. Misalignment of the top or bottom mountings, or mounting pins too tight, may cause scoring of the plungers, leaking, or improper sequencing which could cause the unit to upset.
- It is important that the cylinder is aligned correctly with the truck/trailer frame when installed. The cylinder should be exactly centered in both the vertical axis and the horizontal axis in relation with the truck/trailer frame. Vertically, the cylinder should be perpendicular (90° angle) or should tilt forward.
- The cylinder should be install with enough clearance along its envelope and mounting point to avoid contact with any other parts while dumping which prevent cylinder for damage or side load if body slightly move laterally while dumping.
- Maintain it at least 1/2" of pull out on the cylinder extension. This will prevent the cylinder from bottoming out when in the closed position.
- Protect packings and stages against foreign particles, welding/grinding spatter, paint and dust.
- "Mailhot Industries Inc." recommends the use of a stroke limiter to avoid hard collisions at end of stroke. One of the most popular methods is a pump disengagement cable. This device automatically stops the pump just before the end of the cylinder stroke.
- Another useful device is a body stabilizer. This device allows the body to rise in a parallel axis to the truck, preventing side loading of the cylinder when the truck is on an unlevelled surface or has an uneven load.

The G-SERIES is a rod seal telescopic cylinder which can operate as much as 2,750 psi. Due to the fact that it is a rod seal, the effective force per stage can be calculated with the effective area (from O.D. of each stage) time the working pressure. The capacity of a dumping equipment, should be evaluate at critical point which is the less effective force at beginning of every stage stroke apply to center of gravity of both dump body and load with sufficient factor of safety. Refer to specific cylinder data sheet for dimensions, stroke, maximum working pressure and maximum trust load.

3. GOOD USE AND OPERATION OF THE CYLINDER



WARNING

- **Do not operate the cylinder while personnel or equipment are alongside or behind the dump body or trailer.**
- **Shock pressure can cause severe injury or death and/or damage to cylinder and equipment**

CAUTION

- A cylinder should be allowed to complete its stroke without any obstacle. There should be nothing in the path of the cylinder that could interfere with its natural movement during extension and retraction.
- Always dump on firm and even ground. Do not operate the cylinder with a blow or a severely under inflated tire which may cause dump instability. Do not operate the cylinder when strong winds are present. These situations may cause lateral tilts which can cause damage to the cylinder, misalignment of the cylinder stages and could lead to a possible rollover of the vehicle.
- Always dump with a tractor and trailer are align. Trailers and end-dump trailers should never be unloaded in a jack-knifed position.
- Never drive with a raised dump body.
- Stay out of the working area of an operating dump body. The operator of the equipment should always stay at the controls. If the vehicle starts to tilt, it should be lowered immediately. Always be careful not to lower the body to fast and try to lower in a steady motion. Sudden stopping or jerking can cause a sudden peak in pressure within the cylinder and could cause damage. Do not overload and load evenly. The load should be evenly distributed in the body in a horizontal and vertical manner. A load that sticks to the body increases the risk of tilting or potential rollover. The operator should lower the body to assess the situation.
- Never jerk the body to release a stuck load. This can cause damage to the body, hydraulic system, and the vehicle itself. It is preferable to lower the body and to use a manual or mechanical means to free the material. Do not move the truck and/or use sudden stops with the cylinder extended to free a stuck load.
- Never extend the trailer cylinder in the presence of high voltage electrical lines.

The G-SERIES has no bleeder and is bleeding itself through the hydraulic system. After installation, or when cylinder is bouncing during operation, it is important to cycle the cylinder to full stroke 7-10 times to purge the air out of the system. It is also possible that the oil drain back to reservoir and let air coming in the system when truck is not working for a certain period of time or when connecting the tractor hydraulics to the trailer. In those cases, we recommend to cycle to full cycle 2-3 times. The following suggestions can be follow as guidelines for proper use.

4. RECOMMENDATIONS TO PROPERLY MAINTAIN YOUR CYLINDER



WARNING

- **Worn or damaged hydraulic hoses can cause severe injury or death and/or damage to cylinder and equipment**
- **Never be under an unsupported body**

4.1. DAILY INSPECTION ROUTINE IS ESSENTIAL

A daily inspection routine must be a part of the safety rules and will help to detect problems. When doing your inspection routine, a visual verification is necessary to ensure the good working state of the cylinder and the hydraulic installation to avoid any breakage or leakage that could damage the cylinder or the truck:

- Inspect leaks at the oil tank, pump, cylinder and hoses;
- Ensure that all hoses and fittings are in good condition and secured out of harms way;
- Verify that cylinder attachments and mounting points (blocks, cradle, cover oscillating collar) are lubricated, secure and not worn.
- Ensure that rear hinges are lubricated, secure and without excessive wear.
- Ensure that cover attached to cylinder is secure and without damage. Contact your cylinder service center or manufacturer to correct damaged or loosen cover.

4.2. WEEKLY MAINTENANCE AND LUBRICATION

Maintenance of the equipment is key to have it working to prescribed standards.

- Check hydraulic oil level and cleanliness according to recommendations in this guide. Oil must be compatible with hydraulic system. Never mix oil.
- Check tightness of all hoses and fittings.
- Check tightness of all bolts and nuts at mounting points (blocks, cradle and cylinder cover).
- Never pressure wash your cylinder. Cylinder may ingest water.
- Grease cylinder lubrication zerks at mounting points, blocks, cradle, cover oscillating collar and rear hinge.
- Do not over grease. Excessive grease may drop on stages and this should not be mistaken as packing leakage.

Always use a high viscosity petroleum based grease formulated with extreme pressure, anti-wear and anticorrosion additives including molybdenum disulfide. The lubricant should include a lithium complex thickener to offer good oxidation stability, good shear stability, high temperature protection and to seal effectively against dust and resist the washing effect of water.

**WARNING**

- **A damaged cylinder installed on a vehicle can result in injuries or even death**

4.3. SERVICING A CYLINDER - PRESSURISED OIL

Servicing a cylinder should always be performed by qualified staffs from recommended service center from cylinder manufacturer.

When the cylinder is under pressure, a small leak could allow oil to escape at high velocity causing serious injury. Avoid loose clothing, always wear safety goggles and work gloves when working around a pressured system requiring service.

Great care must be taken because there is always residual pressure that remains in the cylinder. Pressure can remain in a cylinder even after it has been removed and in storage for some time. When stages are moved, even without oil supply, pressure can build up between the stages, especially if an oil port is clogged or blocked. A sudden unclogging, removal of blockage, or leak in a seal can generate enough pressure to cause serious injury.

4.4. CYLINDER AND HYDRAULIC SYSTEM REQUIREMENT

When maintaining the cylinder or any components related to the cylinder, ensure that such components are approved for operating pressure. The maximum operating pressure of the cylinder is specified on the identification label or warning label. Cylinder always requires clean oil.

- The hydraulic oil contamination must not exceed the 20/18/15 class of ISO 4406 Standard to prevent seal deterioration.
- Hydraulic oil and filter must be replaced at least once a year.

There is no bleeder on this cylinder. It is important to make sure that pump and hoses are filled with hydraulic oil prior to pressurizing the cylinder.

4.5. HYDRAULIC OIL

To obtain optimum performances from your hydraulic installation (pump-cylinder) always use oil specifically designed to be used in hydraulic systems with a viscosity grade OF 32 cSt (150 SUS) with anti-friction additives. Also, it is important to verify the chemistry of the oil to ensure that the different components and additives are compatibles with all system parts exposed to this oil.

4.6. HANDLING

When it is time to move the cylinder for either installation, removal or storage, it is important to handle it with great care. Hard knocking of the outer wall should be considered as serious damage or should be treated as such. It is necessary to inspect the cylinder to find any scorching, scoring, leaks of different stages or any other parts that are damaged including: base tube, base attachment, bushing and circlip, zerks, stages, top attachment, and also when cover is present: flange pin, cover tube, cover nut, cover guide and cover trunnion assembly. If leaks or damage are visible and the cylinder is rendered unusable, please bring it back to the closest service center for evaluation by qualified technicians.

4.7. RECOMMANDATIONS FOR SEAL MAINTENANCE AND PARTS REPLACEMENT

 **WARNING**

- **Telescopic cylinders are not design to be used as a structural member or to be side loads or used under abnormal usage.**
- **Driving with a raised dump body or trailer can cause cylinder malfunction, injury or death and/or damage to equipment.**
- **Operating a damaged cylinder and cover components can cause severe injury or death and/or damage to equipment**

Replace seals at the earliest of either:

- Every 4 years;
- According to usage at every 10,000 cycles.

Stages, cover and its connecting flange pin and stover nut are highly stressed components due to environment, application and usage. Unappropriated use may cause cylinder malfunction or failure.

Lateral oscillation of the dump body during a cycle must be avoid. Lateral oscillation of dump body of trailer may occur when lowering dump body with truck in movement, or other irregular situation, and may cause leakage, excessive wear and fatigue of component and connecting members.

In the case of leakage cylinder due to damaged stage, parts must be inspected and replace as necessary.

In the case of excessive wear, unexpected cylinder looseness or broken external of internal component, cylinder must no be used and immediately repair with appropriate parts and methods.

4.8. SUGGESTIONS FOR CYLINDER REPLACEMENT

As a good practice and in a preventive effort to maintain the adequate operational maintenance and security performance, it is suggested to replace the cylinder after 10 years of normal use. It is also suggested to replace the cylinder if a more intense use reaches an estimated 25,000 cycles.

4.9. STORAGE OF CYLINDER

If the cylinder must be stored, it should be protected from bad weather, direct sunlight and extreme temperature variations. Oil ports must be sealed with adapted plugs to avoid dust, water, humidity or any other contaminant to enter into the cylinder. Depending on the length of time spent in storage, some supplemental precautions should be taken. These precautions are showed below;

- A- For a 6 months storage or less, no special precautions others then those stated above.
- B- For a storage period between 6 months and less than 12 months, cylinders should be stored vertically.
- C- If storage period is more the 12 months and less than 24 months, a pressure test must be done to ensure the good state of seals prior to utilisation.
- D- After a storage period of more than 24 months, all seals must be replaced.

If storage facilities are open or non-existent, the cylinder should at least be stored vertically and filled with oil.

TROUBLESHOOTING

PROBLEMS	PROBABLE CAUSES	SOLUTIONS
Cylinder does not extend	<ul style="list-style-type: none"> • Safety or control valves are stuck or broken • PTO or pump not engaged or broken • Cylinder too small • Air trapped in cylinder or system or Not enough oil • Oil tank too small 	<ul style="list-style-type: none"> ☞ Clean or replace the valves ☞ Engage PTO or Change broken parts ☞ Consult body/trailer manufacturer. Select cylinder adequately. ☞ Check for infiltration and correct. ☞ Check oil level and correct. ☞ Cycle cylinder to full extension 7 to 10 times. ☞ Consult body/trailer manufacturer. ☞ Oil tank may be increase according to cylinder capacity.
Cylinder extend too slow	<ul style="list-style-type: none"> • Oil viscosity is too high or oil too cold • Air trapped in cylinder or system or Not enough oil • Pump or valve worn-out • Pump is running too slow. • Pump is too small or PTO speed is too slow 	<ul style="list-style-type: none"> ☞ Warm up oil ☞ Use oil according to cylinder and system specification ☞ Check for infiltration and correct. ☞ Check oil level and correct. ☞ Cycle cylinder to full extension 7 to 10 times. ☞ Change worn-out parts ☞ Increase engine speed ☞ Check cylinder, pump, PTO specification. Change pump or PTO accordingly.
Cylinder extend too fast	<ul style="list-style-type: none"> • Pump is running too high. • Pump is too large or PTO speed is too high 	<ul style="list-style-type: none"> ☞ Reduce engine speed ☞ Check cylinder, pump, PTO specification. Change pump or PTO accordingly.
Cylinder is bouncing or jerks during operation	<ul style="list-style-type: none"> • Air trapped in cylinder or hydraulic system. 	<ul style="list-style-type: none"> ☞ Cycle cylinder to full stroke 7 to 10 times.
Cylinder opens or closes without a smooth operation	<ul style="list-style-type: none"> • Internal parts of the cylinder are too worn-out • One of the stage or gland is swelling or not sliding smoothly. 	<ul style="list-style-type: none"> ☞ Service or replace cylinder. ☞ Verify and replace worn-out parts.

TROUBLESHOOTING

PROBLEMS	PROBABLE CAUSES	SOLUTIONS
Cylinder does not retract. One or more stages of the cylinder stays open.	<ul style="list-style-type: none"> • Cylinder stages are bend or bulged due to side load, misalignment, or over pressurisation. • Cylinder is too fast. As a result, plungers and gland are jamming. • Dumping angle too high 	<ul style="list-style-type: none"> ☞ Check for any misalignment of the cylinder with frame or back hinge, and correct. ☞ Check safety valve setting. ☞ Service or replace cylinder ☞ See “Troubleshooting / cylinder extend too fast”. ☞ Consult body/trailer manufacturer. Stroke may need to be decrease. ☞ Install a limiting device
Cylinder retract too slow	<ul style="list-style-type: none"> • Valve or hoses too small • Oil viscosity is too high or oil too cold 	<ul style="list-style-type: none"> ☞ Consult body/trailer manufacturer. Valve and return line may need to be increase. ☞ Warm up oil ☞ Use oil according to cylinder and system specification
Cylinder retract too fast	<ul style="list-style-type: none"> • Material stuck in bed – dumping angle too low. • Cylinder too small, body/trailer too heavy, Valve or hoses too large. 	<ul style="list-style-type: none"> ☞ Consult body/trailer manufacturer. stroke may need to be increase. ☞ Consult body/trailer manufacturer. Select parts adequately.
Cylinder is leaking oil	<ul style="list-style-type: none"> • Seals are worn due to high cylinder speed. • Seals are worn or stages are score due to oil contamination. • Seals are worn or stages are scored due to sideload or miss-alignment of the cylinder. • Grease drop on stages. 	<ul style="list-style-type: none"> ☞ “Troubleshooting / cylinder extend too fast or cylinder retract too slow”. ☞ Check oil cleanliness, replace as necessary. ☞ Verify and correct alignment. ☞ Change worn-out parts. ☞ Oil leakage may be mistaken. Rag stage and excessive grease.
Cover guide in contact with moving stages during operation	<ul style="list-style-type: none"> • Cylinder is side loaded due to misalignment or incorrect use. • Loosen or damaged cylinder, flange pin, lock nut or cover parts. 	<ul style="list-style-type: none"> ☞ Check for any misalignment of the cylinder with frame or back hinge, and correct. ☞ Fully read and understand this user guide for cylinder usage. ☞ Service or replace cylinder
Noisy cylinder or cover	<ul style="list-style-type: none"> • Bent or bulged moving stage. • Loosen or damaged cylinder, 	<ul style="list-style-type: none"> ☞ Check for any misalignment of the cylinder with frame or back hinge, and correct. ☞ Service or replace cylinder