

Technical information **Dimensions** **Imperial** **Metric**

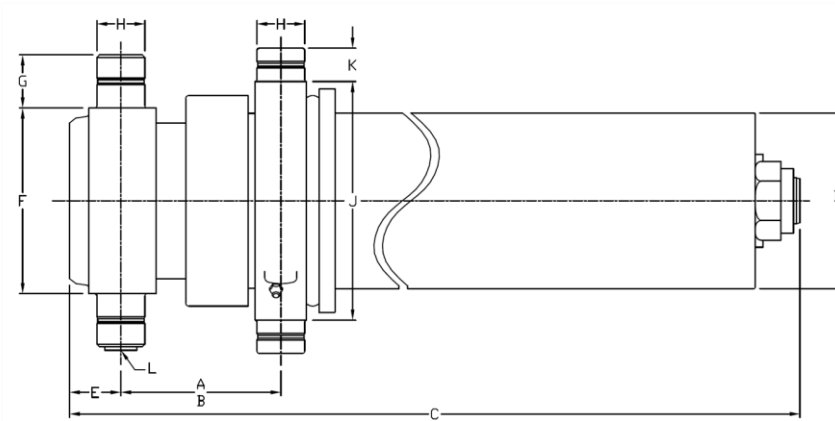

Dimensions	Imperial	Metric
A (stroke)	175.00 in	4 445 mm
B (closed)	9.63 in	244 mm
C	64.38 in	1 635 mm
D	8.50 in	216 mm
E	2.50 in	64 mm
F	9.00 in	229 mm
G	2.00 in	51 mm
H	2.25 in	57 mm
J	11.19 in	284 mm
K	1.50 in	38 mm
L	SAE-16	

Stage	Effective diameter		Effective area		Stroke	
1	6.673 in	169 mm	34.97 in ²	22 563 mm ²	48.50 in	1 232 mm
2	5.793 in	147 mm	26.36 in ²	17 005 mm ²	48.56 in	1 234 mm
3	5.000 in	127 mm	19.64 in ²	12 668 mm ²	49.00 in	1 245 mm
4	4.250 in	108 mm	14.19 in ²	9 152 mm ²	28.94 in	735 mm

Specifications	Imperial	Metric
Weight without hydraulic fluid	648 lb	295 kg
Hydraulic fluid volume	21.0 gal. (US)	79 l
Maximum working pressure	2 750 psi	190 bar
Maximum pump flow	50 gpm	189 lpm
Maximum cylinder capacity*	37.1 US tons	33 657 kg

Installation components	Model	Part no.
Block	B-2250	PB3005003-A
Frame	AC-4050	PF3000015
Hinge	P-250 PEL-T	PP3004012

Cylinder capacity

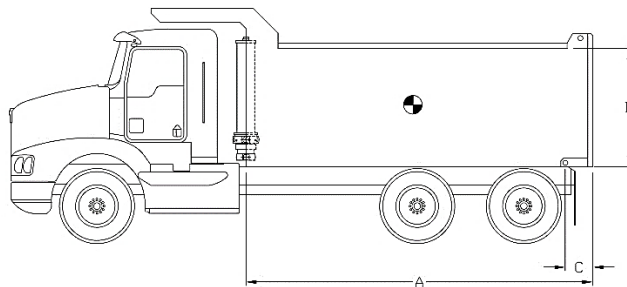

A = Body Length
 B = Body height
 C = Overhang

Note:	Body length	18.0 ft		19.0 ft		20.0 ft	
Cylinder capacities based on 90% of the maximum working pressure.	Overhang	6 in	12 in	6 in	12 in	12 in	18 in
	Dump angle	49.5°	51.1°	46.6°	48.0°	45.3°	46.6°
	Body height	Cylinder capacities in US tons at 2000 psi (at 2750 psi)					
For reference only. See www.mailhotindustries.com	36 in	38.1 (52.4)	40.8 (56.0)	36.3 (49.9)	38.4 (52.8)	36.6 (50.4)	38.7 (53.3)
	48 in	40.6 (55.8)	43.7 (60.1)	38.2 (52.5)	40.7 (56.0)	38.5 (53.0)	41.0 (56.3)
	60 in	43.3 (59.6)	47.2 (64.9)	40.4 (55.5)	43.4 (59.6)	40.6 (55.8)	43.5 (59.8)

* See product manual

Subject to change without notice, all rights reserved.

Item	Part no.	Description
------	----------	-------------

1	ROV077025-A	BASE TUBE Ø7,7
2	RMG067155-A	SECTION Ø6,7
3	RMG057154-A	SECTION Ø5,7
4	RMG050153-A	SECTION Ø5
5	RNV042043-A	LAST SECTION Ø4,25
7	RK085131-A	COVER TUBE ASSEMBLY
8	RFG071017	END CAP Ø7-1/8
9	RFG071016	END CAP Ø7-1/8

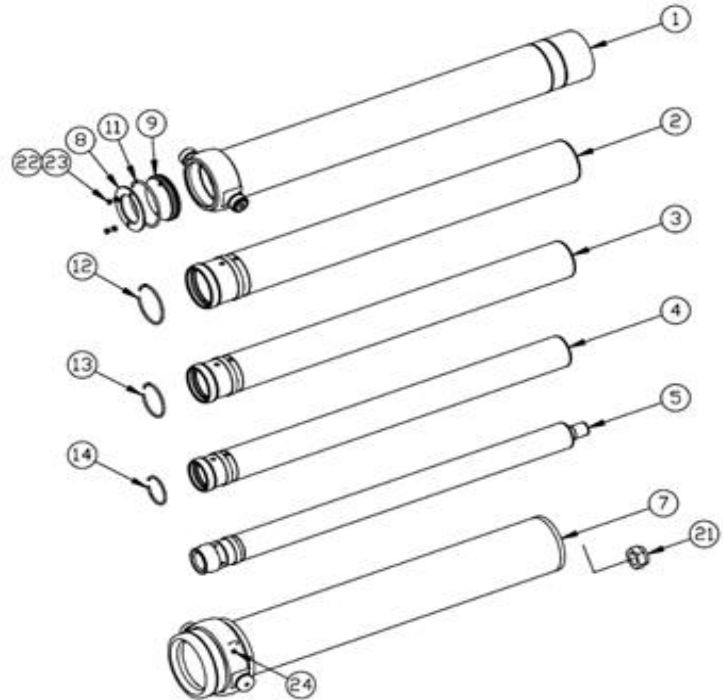

Snap ring kit Part no. : XB19G0674

Item	Description
------	-------------

11	SNAP RING Ø7-1/8
12	SNAP RING Ø6-1/16
13	SNAP RING Ø5-1/4
14	SNAP RING Ø4-1/2

Hardware kit Part no. : ZX02G0674

Item	Description
------	-------------

21	STOVER NUT Ø2-12 NF GRADE C
22	SERRATED SPRING LOCK WASHER
23	HEX BOLT Ø1/2-13 UNC X 1 LG GRADE 5
24	GREASE FITTING STRAIGHT 1/8 NPT

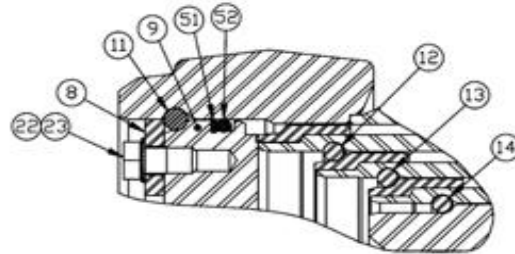

Seal kit Part no. : UI47G0674

Item	Description
------	-------------

31	U-CUP Ø7.175 X Ø6.675 X 9/16
32	U-CUP Ø6.170 X Ø5.795 X 3/8
33	U-CUP Ø5-3/8 X Ø5 X 3/8
34	U-CUP Ø4-5/8 X Ø4-1/4 X 3/8
41	WIPER Ø6.675
42	WIPER Ø5.795
43	WIPER Ø5
44	WIPER Ø4-1/4
51	BACKUP RING Ø7-1/8 X Ø6-3/4
52	O-RING Ø7-1/8 X Ø6-3/4

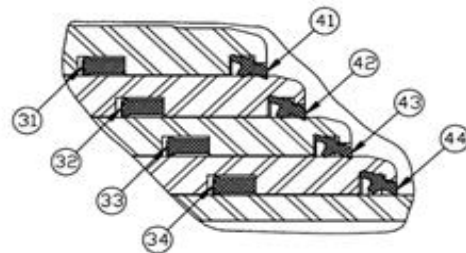

* See product manual

Subject to change without notice, all rights reserved.